

[420] LAYING FLOOR COVERINGS WITH ELECTRICAL PROPERTIES, USING GTI EL5 CONTROL TILES WELDED WITHOUT SKIRTING



Ambient temperature
Minimum: 10° C



Substrate temperature
Minimum: 10° C

Before laying the flooring, it is a good idea to inspect it and to identify any problems with the appearance. If there are visible defects, please notify GERFLOR and wait to hear from them before laying the flooring.

MATERIALS	FORMAT	CODE	NOTES
GTI EL5 CONTROL	650 X 650 / Th 6 mm	2714 followed by colour code	
Copper strip	W(width) 10 mm / Th 0.08 mm	0586 0001	self tape copper strip is not permitted
Welding rod	100 ml	2722 followed by colour code	
Permanent adhesive or acrylic glue	Any make of acrylic glue		

ANTISTATIC ASTATIC FLOORINGS (ASF) < 2kW

Standard fitting. These floorings do not require any specific fitting method. [No copper strip required]

DISSIPATIVE (DIF) AND CONDUCTIVE (ECF) FLOORINGS

Fitted using a permanent adhesive or acrylic glue only under the axis + copper strip: code 0586 0001 (length: 200 ml)
Store the tiles for 24 hours in the room where they will be fitted.

REQUIREMENT SPECIFICATION FOR CONDUCTIVE FLOORINGS:

It is the responsibility of the client and/or contractor to set out the applicable standard in the requirement specification.

METHODS FOR RESILIENT FLOOR COVERINGS:

Europe: EN 1081. Transverse resistance and surface resistance on tripod
USA: ASTM F150 /NFPA 99 (2 cylindrical electrode)

METHODS FOR ELECTRICAL INDUSTRIES:

Europe: CEI 61340-4-1
USA: ANSI/ESD S 7.1
For all other methods, see F Material technique

1. CHOICE OF JOINT TREATMENT

This material is laid edge to edge, **with or without** skirting.

FINISH	
	Joints hot welded with two-layer conductive seam + caulked at the edges (leave a 3 mm gap to apply mastic)
	Joints hot welded with two-layer conductive seam + skirting

See the section on FINISHES - "Joint treatments". * Skirting must be installed after the flooring is laid.

2. LAYING

Preparation

Moisture content 7% at 4 cm with a carbide bomb test.
This flooring must be laid on a DTU 13.3 compliant substrate.
To guarantee good conductivity between the tiles, you must ensure that the substrate is level.
Because this flooring has specific electrical characteristics, you are recommended to lay it as follows.

■ 2.1 - MARKING OUT AND LAYING THE STRIPS

- Mark out the two perpendicular axes, making sure the cuts are the same on each side
- Use a roller to apply the permanent adhesive or acrylic glue evenly

over the two axes with a coverage of about 100 to 150 g/m².

- Leave to set according to the manufacturer's instructions.
- Lay one copper strip for **every 3 rows, in one direction**, holding it down with adhesive tape (**see diagram**)
- **Encircle the room with a copper strip under the cut tile at least 5 cm from the walls**
- An earthing line must be provided for every 40 m². Leave 50 cm of the strip spare to allow the electrician to make the connection
- The copper strip can be located later with remote imaging.

Self tape copper strip is not permitted.

[420] LAYING FLOOR COVERINGS WITH ELECTRICAL PROPERTIES, USING GTI EL5 CONTROL TILES WELDED WITHOUT SKIRTING

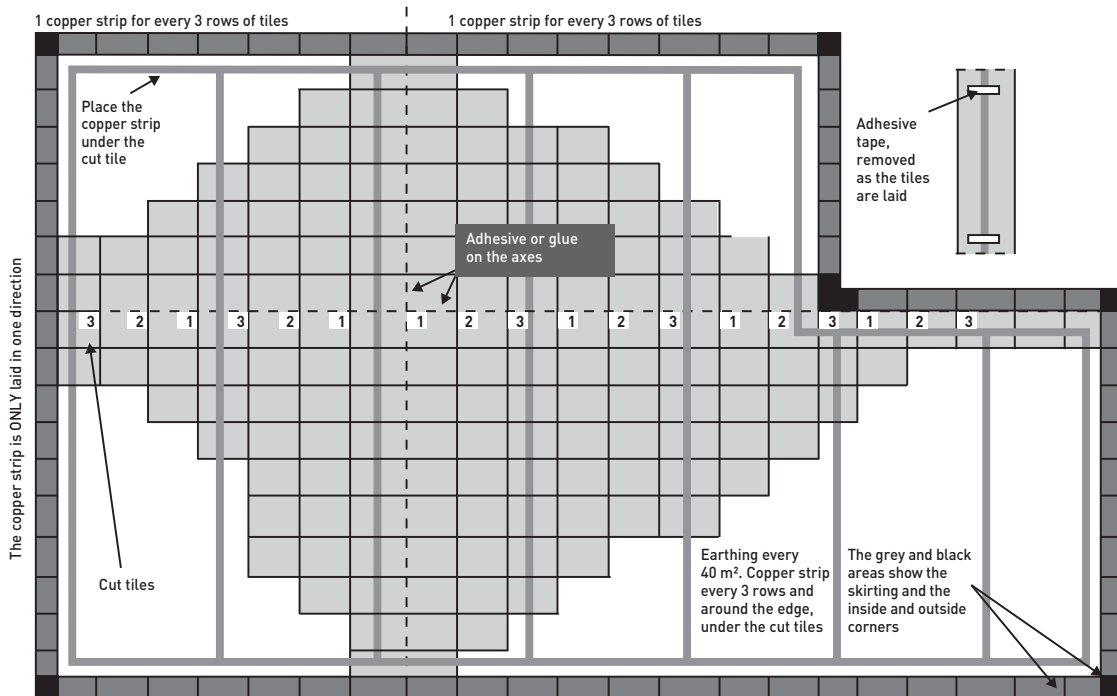

2.2 - LAYING THE TILES

Precautions

- 1- The tiles are supplied on pallets. Different batches must not be mixed together
- 2- Laying direction: Tiles are ALL laid in the same direction. Observe the direction indicated by the area on the back of the tile.
- 3- Pressed materials, such as GTI tiles, may have dimensional tolerances between series or between colours. In this case, the tiles can become slightly offset. Therefore, the entire row of tiles must be overlapped to continue laying. These two rows will be hot-welded.

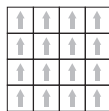

- Cut the tile cleanly then put it in position
- To help, you are recommended to heat the material with a hot-air paint stripper
- This method means that no jigsaw is necessary

More difficult cuts (door frames, etc.) may be made using a jigsaw or high leverage nippers. If there is a lot of cutting, we recommend keeping a circular saw on site.

When planning the edge cuts, make sure that they are the same on each side and that the tiles are not cut to less than half the width of a tile plus caulking gap (see drawing).

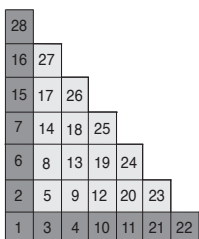

Lay the first tile and continue in a staircase pattern, following the axes you marked out. The tiles must be in contact with the substrate. Remove the adhesive tape from the strip as you work.

Tiles laid to guidelines
 Order of laying other tiles

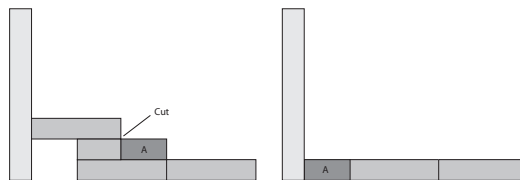

2.3 - EDGING

Cuts are made:

- Either using a cutter (make one marking cut and two surface cuts before snapping the tile)
- Or by scribing. Scribing: method for drawing or cutting parallel lines. A scribe device or an uncut tile can be used.
- Place the tile being cut on the last uncut tile laid
- Take an uncut tile to act as a template
- Place it on the tile you want to cut, pushing it against the partition (wall)
- Leave a gap of 5 mm
- Take the tile you want to cut and mark along the edge of the template, using a knife with a straight blade

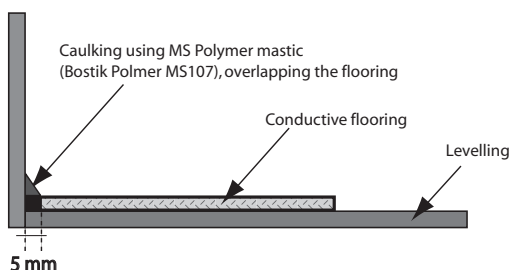

FLOORS IN BUILDINGS

[420] LAYING FLOOR COVERINGS WITH ELECTRICAL PROPERTIES, USING GTI EL5 CONTROL TILES WELDED WITHOUT SKIRTING

2.4 - HOT WELDED JOINTS

The tile joints are welded with a two-layer conductive seam.

The two-layer conductive seam leaves a black thread after levelling. This thread provides conductivity between each tile.

IMPORTANT:

- The tiles are not supplied chamfered, but bevelled as a guide for the chamfering tool
- The removed two-layer conductive seam may leave marks on the flooring. You are recommended to collect the removed pieces as you work
- To prevent poor welds where the tiles intersect, it is necessary to chamfer, weld and level in one direction before repeating in the other direction

To prevent deposits forming as you create the welds, we recommended the following:

- Stay within the temperature range 400 – 500°
- Follow the recommended speed: Position 3
- Clean the nozzles regularly

2.4.1 Chamfering

- **Chamfer the joints** using an electric chamfering machine, blade width 3.3 mm, depth 1.5 to 1.8 mm
- Use a triangular grooving tool to chamfer along the skirting

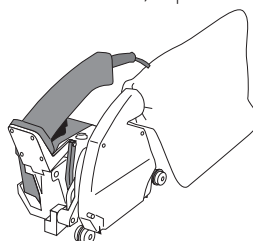
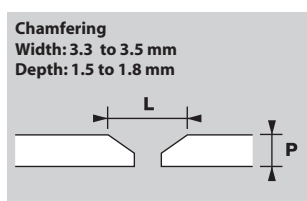
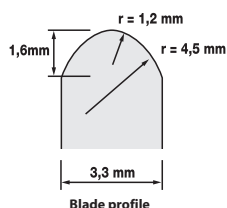

Chamfering machine

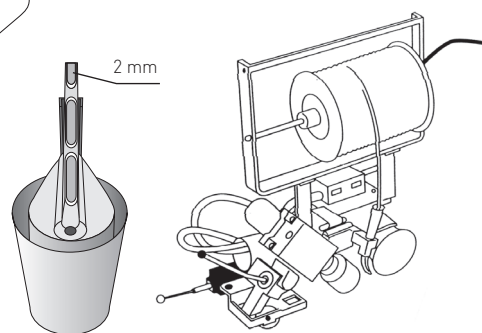

Narrow nozzle

2.4.2 Welding

- **Hot weld the joints** using a welding machine.

Use a LEISTER UNIVERSAL or UNIFLOOR hot air welding machine with electronically controlled heating, fitted with a narrow multi-outlet nozzle designed for this purpose.

TOOLS	ROMUS CODE	JANSER CODE	LEISTER CODE
Narrow nozzle	95254	225 860 040	105 407

- **A Leister Triac S handheld hot air tool must be used at the start and end of the weld**

Joining or repairing welds

To prevent carbon black build-up during repairs:

- Make an initial levelling cut of the seam
- Clean the joint with a vacuum cleaner to remove the particles and run a triangular scraper over it
- Make a notch at both ends of the seam
- Use a hot air tool with the Rapid nozzle as explained above, starting and ending at the existing welds (about 5 cm).

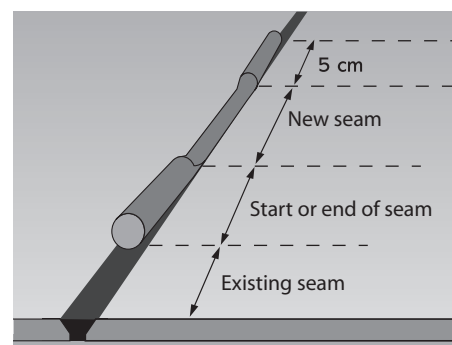

2.4.3 Levelling the seams

- Using a MOZART knife:

First pass: make an initial cut by placing the levelling guide under the MOZART knife blade (fig. 1)

Second pass: leave the seam to cool down completely

Rotate the levelling guide to 90° on the side to completely remove the excess seam material (fig. 2)

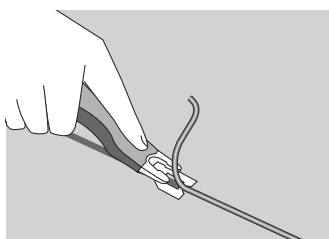

Fig. 1 - Levelling guide under the blade

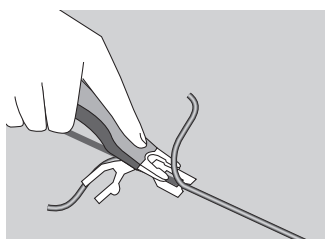

Fig. 2 - Levelling guide at 90°

TOOLS	GERFLOR CODE
MOZART knife	0561 0001
Spare blades	0542 0001

This method prevents hollow welds.

[420] LAYING FLOOR COVERINGS WITH ELECTRICAL PROPERTIES, USING GTI EL5 CONTROL TILES WELDED WITHOUT SKIRTING

3. CORNERS AND DOORWAYS

3.1 - ENDS AND DOORWAYS

Use the following profiles depending on conditions of use: traffic, humidity, etc.

3.1.1 Heavy traffic, pallet trucks...

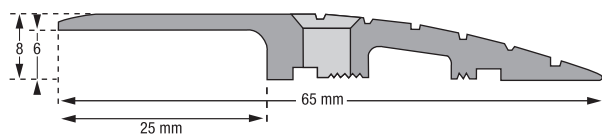

Finishing profile H 0505

3.1.2 Moderate traffic

GTI EL5 CONTROL ACCESS AND CORNER		
GTI EL5 CONTROL ACCESS	635 x 320 mm	Code : 2715 followed by colour code
GTI EL5 CONTROL CORNER	320 x 320 mm	Code : 2716 followed by colour code

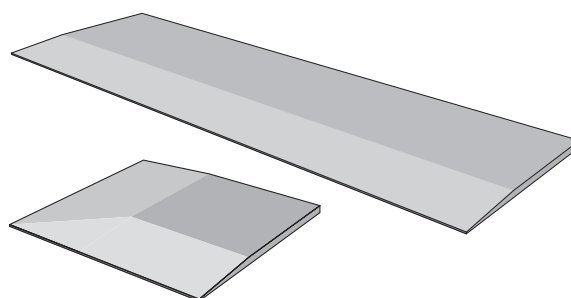

These accessories must be glued down, either using a 2 components PU adhesive and weighted until the adhesive sets (6 to 12 hours), or using an acrylic double bonding adhesive.

4. FIRST USE

For normal traffic, the floor can be walked on immediately after welding.
To move furniture, lay panels to distribute the load.
Do not allow rubber feet to be used on furniture.

5. UNDERFLOOR HEATING

Underfloor heating should be turned up gradually over the seven days after the flooring is laid.

6. MAINTENANCE

FINAL CLEANING

The floor covering can be used as soon as it is laid, but take these precautions:

- Deposits or scuffing remains from the seam
- Dampen a clean cloth with alkaline detergent and gently rub to clean the marks
- Then wipe with a sponge dampened with clean water

DO NOT ATTEMPT TO CLEAN BY HAND OR USING A DRY CLOTH

After the marks are removed, flooring must be cleaned as follows:

- Remove dust and particles using a broom or an industrial vacuum cleaner
- Clean the floor with a scrubber drier using an alkaline detergent
- Rinse with clean water to remove all traces of the detergent
- Leave to dry

DAILY CARE

Refer to the care sheet for the product.