

DEBUT PAGE SUIVANTE
BEGINNING WITH THE FOLLOWING PAGE

merci d'utiliser les feuilles de styles
please use the style sheets

FINISHES AND TECHNICAL SOLUTIONS





**FINISHES AND
TECHNICAL
SOLUTIONS**

210 - 271

Finishes

212 - 233

Sport finishes

234 - 239

Technical solutions

240 - 271



FINISHES

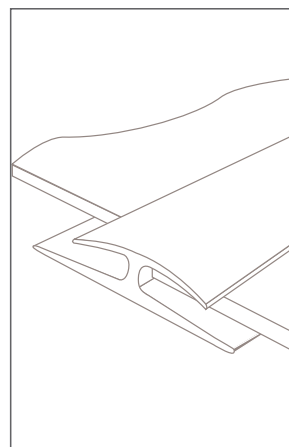
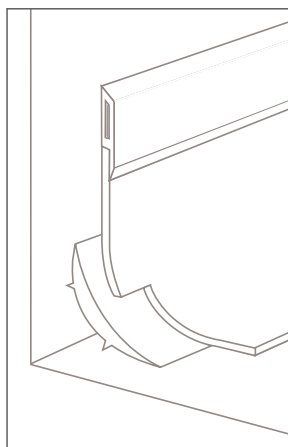
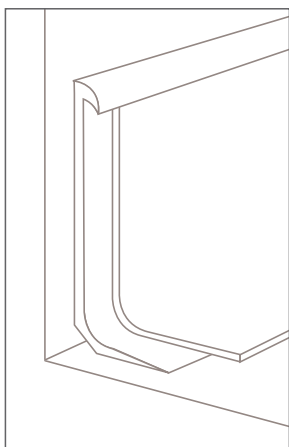

Gerflor provides a complete range of solutions including skirting, stairs, profiles and welds.

Skirting solutions _____ P 214

- Semi-rigid skirting P 216
- Flexible skirting P 216
- Set in skirting P 217
- Coving solutions P 218

Stair solutions _____ P 222

- Stair Clip System P 224
- Stair nosing P 224

Profile solutions _____ P 226

- Connecting profiles P 228
- Ramp edges P 230

Weld solutions _____ P 232

- Hot weld P 233
- Cold weld P 233

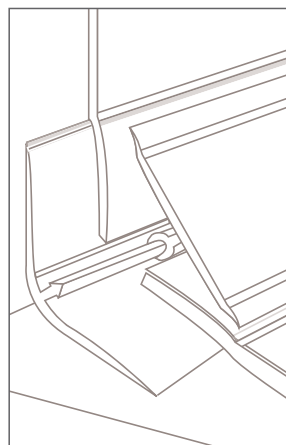
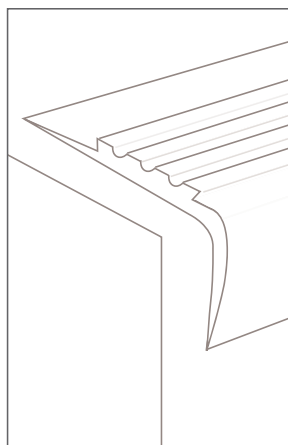
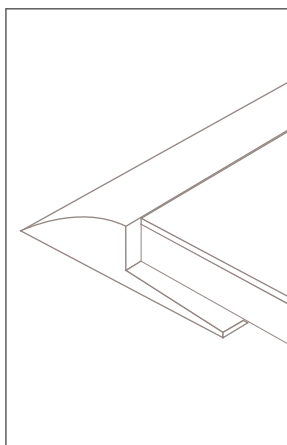
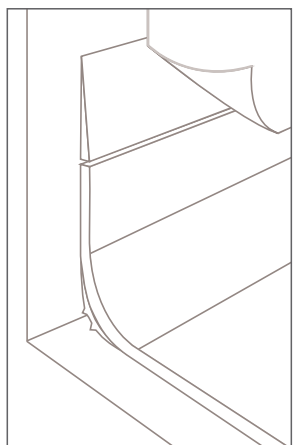

SKIRTING AND COVING

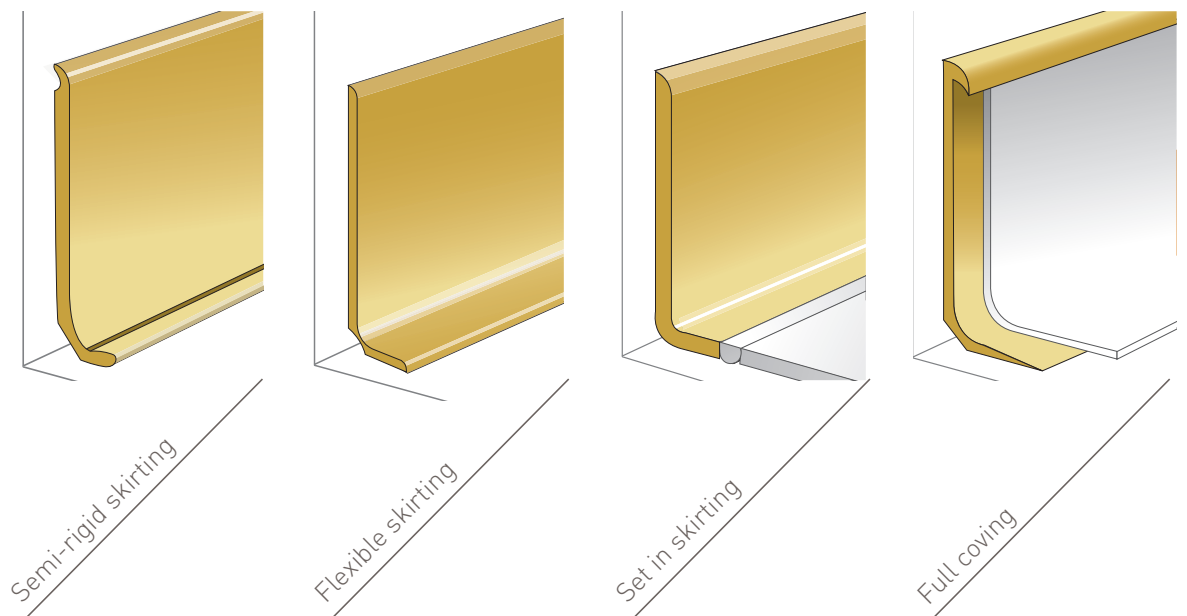

There are two ways of finishing the junction between the floor and wall:

- 1** Installing the PVC covering up to the edge of the wall and using a skirting insert.

This is cost effective and time saving.

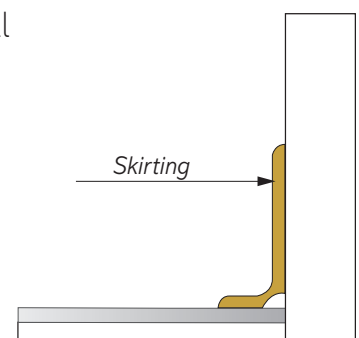

SOLUTIONS

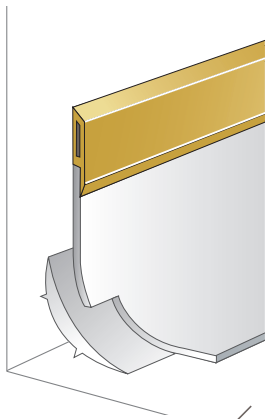

Capping strip

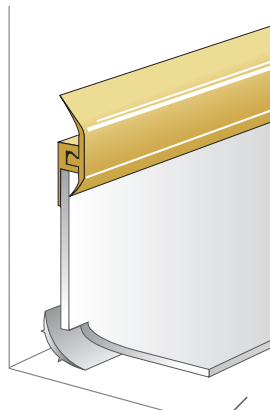

Capping strip -
Clip system

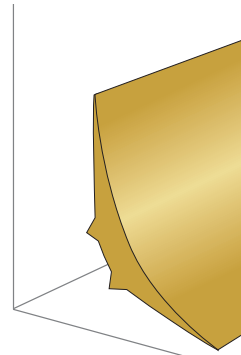

Cove former

2

Making a cove.

This solution makes it easier to clean inside angles and edges. It gives a waterproof connection wall/floor covering.

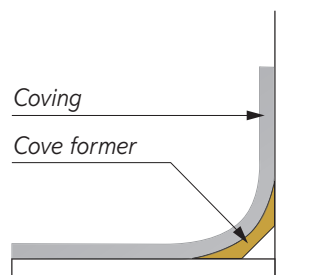

FINISHES

SKIRTINGS

Description

Semi-rigid skirting

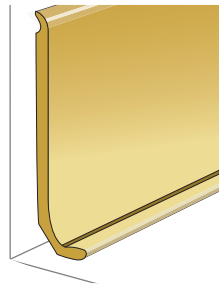

VYNAFLEX

Semi-rigid PVC skirting to be placed on the wall

0483 - 0482 - 0477

Flexible skirting

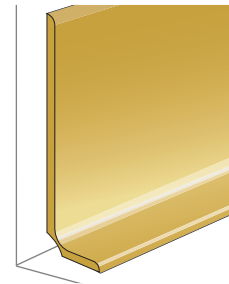

FLEXIBLE SIT ON

PVC skirting

► To be placed on the covering

0475 - 0474 - 0472 - 0471

Colors

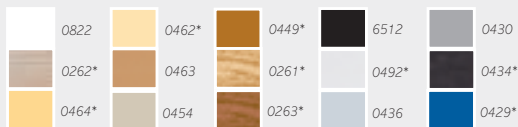

* available only for 60 mm et 80 mm

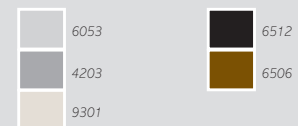

Benefits

- Solid colour
- Resistant to washing waters
- **Stylish**, wood design

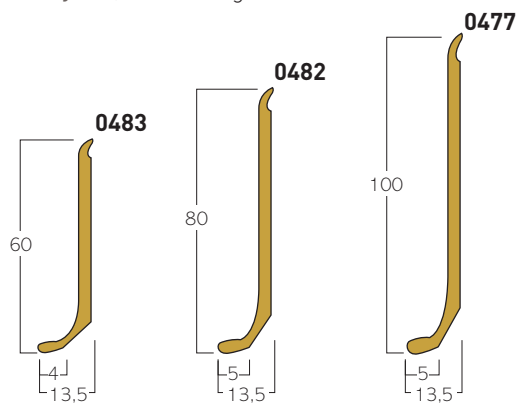

- Floor/wall junction of rooms and corridors
- Can be used with non-planar walls
- **Easy to install**

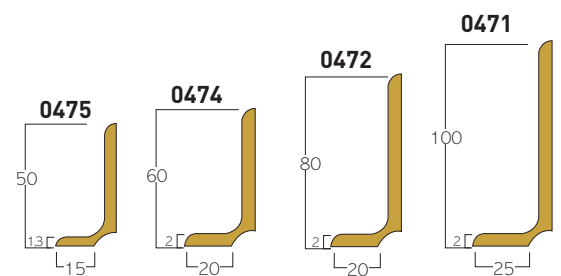

Tips

- Use skirting corner Cutter to handle internal and external angles
- Use either a double bonding adhesive, a dispersion contact adhesive or a double sided tape compatible with the PVC skirting
- Apply an adhesion primer if the sub-floor is porous

- Use either a double bonding adhesive, a dispersion contact adhesive or a double sided tape compatible with the PVC skirting
- Apply an adhesion primer if the sub-floor is porous

SKIRTINGS

Flexible skirting

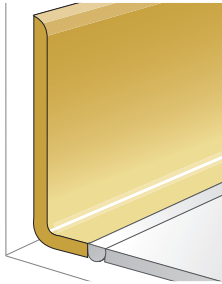

FLEXIBLE SET IN SKIRTING

Flexible PVC skirting

- ▶ To be placed at the same level as the wall
- ▶ To be welded to the floor

0470

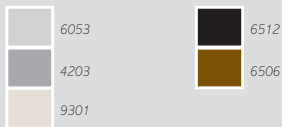

- ▶ Replaces coving
- ▶ Provides **watertight seal**

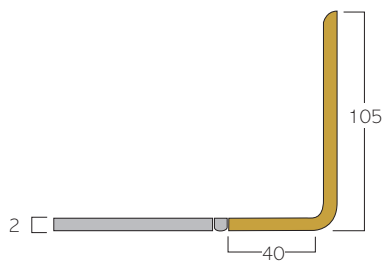

- Use either a double bonding adhesive, a dispersion contact adhesive or a double sided tape compatible with the PVC skirting
- Apply an adhesion primer if the sub-floor is porous

Colours and images are not contractual.



FINISHES

COVING SOLUTIONS

PVC Capping strips

Description

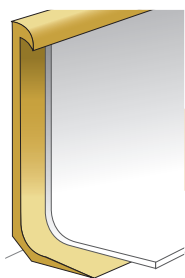

0481

FULL COVING

PVC profile combining the cover former and the capping strip into a single product.

- ▶ Adapted to the hospital sector and any room requiring a waterproof skirting.

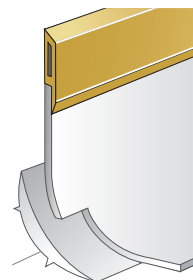

0491

CAPPING STRIPS

Rigid capping strip with flexible lip

- ▶ Do not use in commercial kitchens and showers

Colors

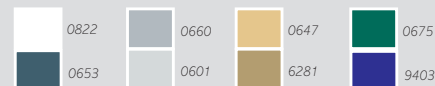
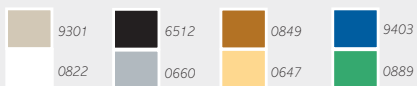

Benefits

- ▶ Maximum floor covering thickness **4 mm**
- ▶ **Compensates sub-floor defects**
- ▶ **Hygienic** and makes cleaning angles easier
- ▶ Guarantees **watertightness**
- ▶ **Quick to install**

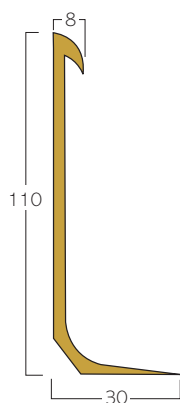

- ▶ Maximum covering thickness: 4 mm
- ▶ **Hygienic**
- ▶ **Easy to install**

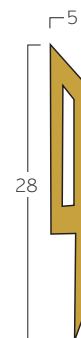

Tips

- Heat the skirting with a heat gun in order for it match the shape of the wall
- Use either a double bonding adhesive, a dispersion contact adhesive or a double sided tape compatible with the PVC skirting

- Slightly heat the strip if it whitens once installed
- Use a miter shear for a perfect cut
- Use either a double bonding adhesive, a dispersion contact adhesive or a double sided tape compatible with the PVC skirting

COVING SOLUTIONS

PVC Capping strips

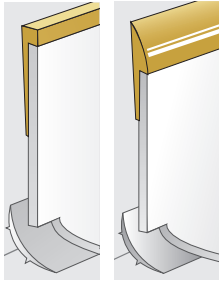

P1509 / P769

Finishes that can be welded to the floor covering

- ▶ Do not use in commercial kitchens and showers

0496

0493

P1509		4203	P769		4203
		6512			6512
					6506

- ▶ P769: Adapted to 2 mm floors
- ▶ P1509: Adapted to 2.2 mm floors

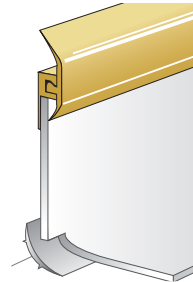
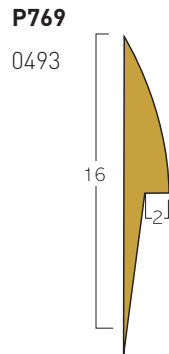
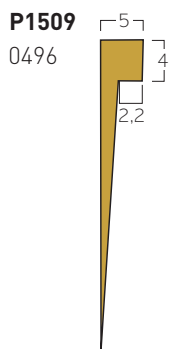

CAPPING STRIP- CLIP SYSTEM

Rigid clipped finishing profile with 2 flexible lips

- ▶ Capping strip that covers the skirting

0492

	0660		0626		0653		9201		0647
	0601		0624		9403		4206		6281
	0822		0672		0675		0682		4207

- ▶ Maximum floor covering thickness: 4 mm
- ▶ Good watertightseal for finishing floor-wall covers and floor-wall systems notably in industrial kitchens
- ▶ **Easy to install** thanks to the clip system



- May also be used as a floor stopping profile
- Weld with SG916
- Use either a double bonding adhesive, a dispersion contact adhesive or a two-side adhesive compatible with the PVC skirting

Colours and images are not contractual.

- Heat the profile with a heat gun (temperature about 150°C) for the installation of the external corners
- Use a miter shear for a perfect cut
- Use SG916 for a perfect finish of the internal corners
- Slightly heat the profile if it whitens once installed
- Use either a double bonding adhesive, a dispersion contact adhesive or a double sided tape compatible with the PVC skirting

PVC COVE FORMER

Description

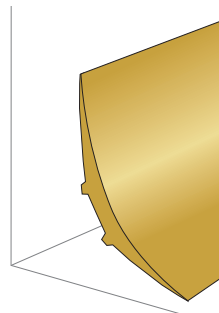

COVE FORMER

This accessory allows the floor-wall cove to be formed.

0478 - 0479 - 0480

Colors



6512

Benefits

- ▶ Its rounded shape **makes it easier to clean** the floor-wall junction.
- ▶ Gives a better look
- ▶ Limits the risk of piercing the floor covering
- ▶ **Prevents accumulation** of dirt and bacteria

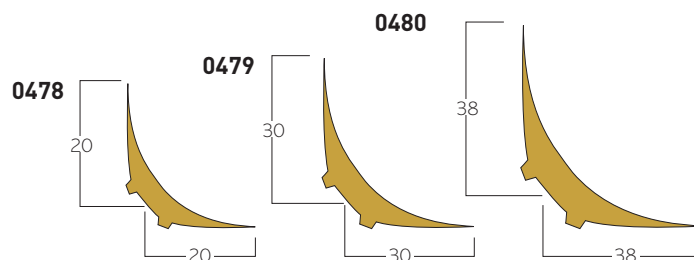

Tips

- *Use a miter shear for a perfect cut*

SELECTION GUIDE

Skirting

	Semi-rigid skirting		Flexible skirting	
	Vynaflex		Sit on	Set in
	Semi-rigid skirting, wood design		Skirting - positioned on covering	Flexible skirting - welded to the floor
Criteria	Product performance characteristics			
Design	***	*	*	*
Aesthetic appeal	****	*	*	*
Cost	**	****	**	**
Watertightness	*	*	***	***
Impact resistance	**	***	***	***
Where?	Home - Office - Retail Service sector - Industry		Schools - Leisure	Health - Industry

Cove formers and capping strips

	Capping strips				
	Full coving	Capping strip	P769	P1509	Clipped
	Cove former with capping strip	Rigid with 1 flexible lip	Can be welded to the floor covering	Can be welded to the floor covering	Rigid with 2 flexible lips
Criteria desired	Product performance				
Hygiene	**	**	***	***	****
Watertightness	**	**	*** (in case of welding)	*** (in case of welding)	****
Floor covering thickness	Up to 4mm	Up to 4mm	2mm	2.2mm	Up to 4mm
Where?	Health Industry	Health Industry	Hospitals, in bedrooms and corridors	Hospitals, in bedrooms and corridors	All rooms as well as in commercial kitchens

LEGEND

-	+		
*	**	***	****

Refer to the product glossary for information on colours and packaging

STAIR

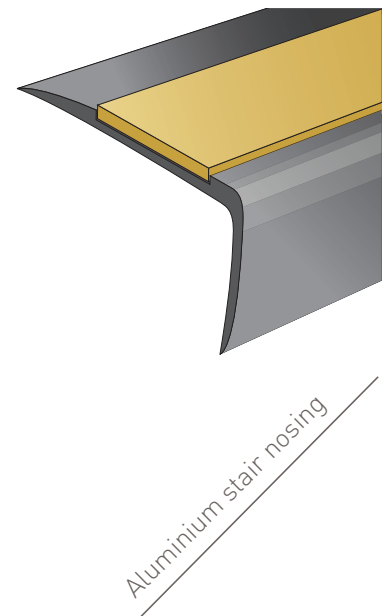
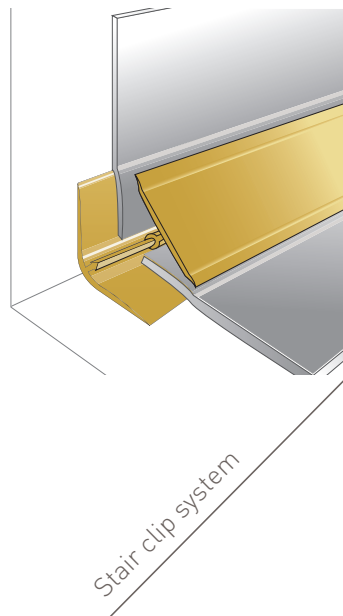

Gerflor has developed 2 solutions for installing a Vinyl floor on stairs to complement

1 Tarastep

- ▶ Install the base of the finishing clip onto the flat angle of the stair
- ▶ Install the Tarastep
- ▶ Clip the stair clip system

Adapted to rounded stair nosing.

Mill the angle for straight stair nosing.

For bird's beak stair nosing, fill the void beforehand.

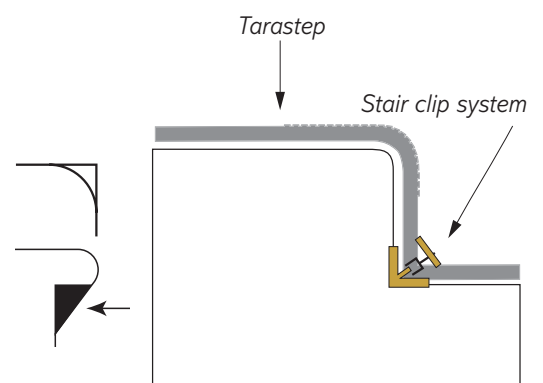

SOLUTIONS

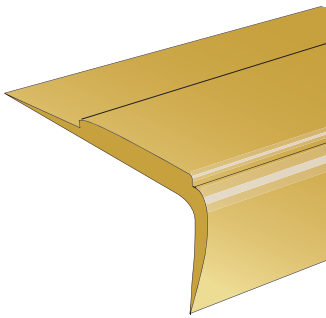

Smooth stair nosing

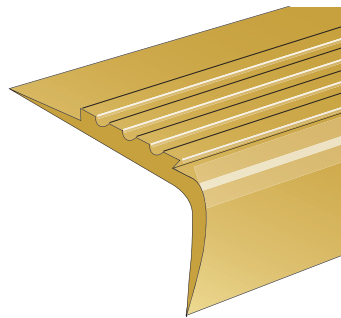

Grooved stair nosing

its range of floors:

2

Stair nosing insert

- ▶ Install the vinyl flooring and the stair nosing by starting at the bottom of the stair
- ▶ Install the riser
- ▶ Install the stair nosing
- ▶ Install the flat of the stair
- ▶ Weld

Adapted to straight stair nosing, rounded stair nosing and bird's beak stair nosing.

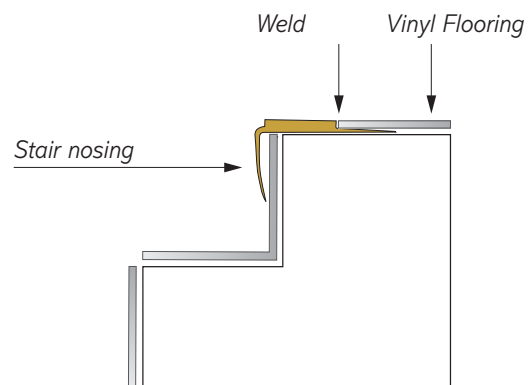

STAIRS

Description

PVC product installed with the Tarastep

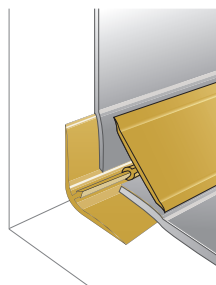

STAIR CLIP SYSTEM

- ▶ Perfect stair finish, highlights the bottom of the stair

H138

Stair nosing insert

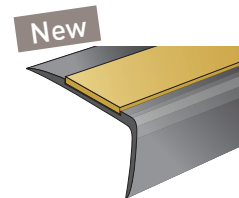

0557

ALUMINIUM STAIR NOSING T67 ALU

- ▶ Cuts the floor covering colour for safety signage
- ▶ landing/stair harmony
- ▶ Guarantees floor covering durability

Colors

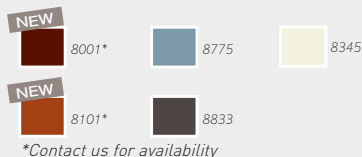

*Contact us for availability

To be used with

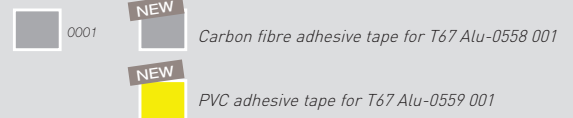

Benefits

Ensures:

- ▶ Better **watertight seal**,
- ▶ A better **look**,
- ▶ **Durability** of the floor covering
- ▶ **Easy maintenance**

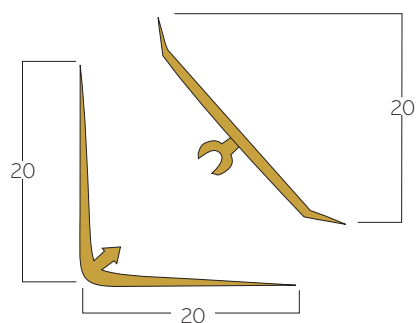

▶ For a state-of-the-art stair finish

- ▶ Grey and yellow strips for the safety of people with visual impairments

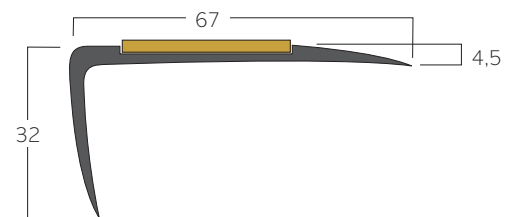

Tips

- *Tip: Slightly heat the stair clip system if it whitens once installed.*
- *Use a miter shear for perfect cut*
- *The base is installed prior to the floor covering, then clip in the cover.*

- *Secure with flat head cross head countersunk stainless steel screws (not included).*

STAIRS

Stair nosing insert

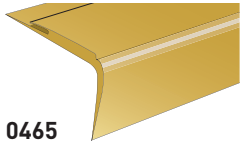

SMOOTH PVC STAIR NOSING
T766

0465

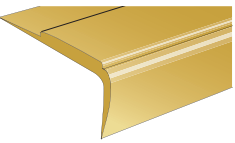

T49/2G - T594/2G
Straight angles
▶ Landing/Stair harmony
▶ Ensures floor covering durability

0460 - 0463

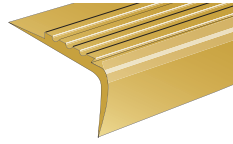

GROOVED PVC STAIR NOSING
T49/3R - T49/2R - T594/2R
Straight angles

0462 - 0461 - 0464

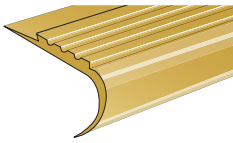

T27/3R
Rounded angles and bird's beak

- ▶ Grooves provide anti-slip protection
- ▶ Landing/Stair harmony
- ▶ Ensures floor covering durability

0467

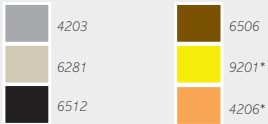

*available only for T49/2G

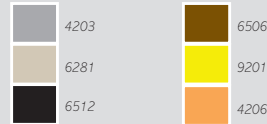

*available only for T49/2R

- T766 :
- ▶ Adapted to 4 mm floor covering
 - ▶ Provides floor covering protection

- T49/2G
- ▶ Adapted to 2 mm floor covering
 - ▶ Weldable

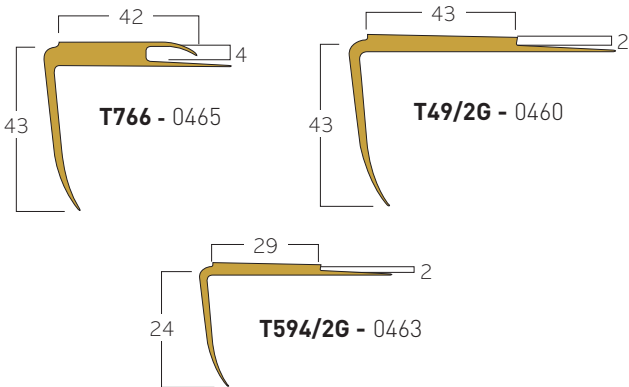

- T49/3R - T49/2R - T594/2R :
- ▶ Adapted to 2 or 3 mm floor covering
 - ▶ Weldable

- T27/3R :
- ▶ Adapted to 3 mm floor covering
 - ▶ Weldable

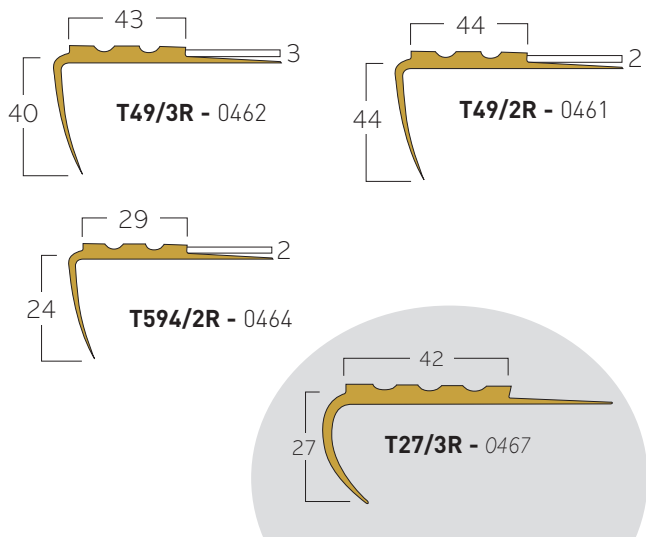

- Do not apply adhesive to the vertical part of the stair nosing
- Double bonding

Colours and images are not contractual.

PROFILE

Our profiles provide solutions to several problems concerning flooring thickness and technical requirements

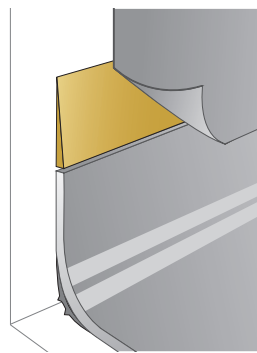

Diminishing profile

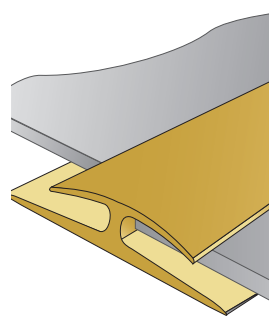

Connecting profile

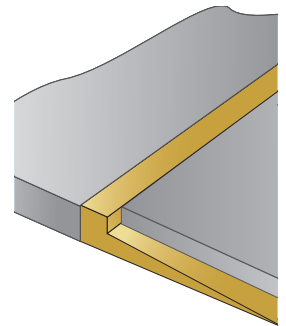

Connection profile

They in particular, allow two types of connections to be dealt with:

1 Connecting profiles

The connections between two floor coverings

- ▶ Floor/Floor
- ▶ Floor/wall

Allow the link between two floor coverings with different thicknesses.

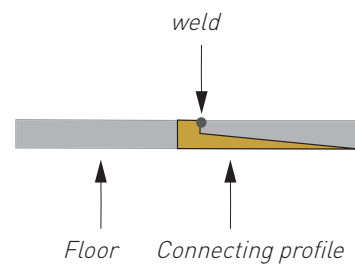

SOLUTIONS

links between floors, walls or bare spots depending on the

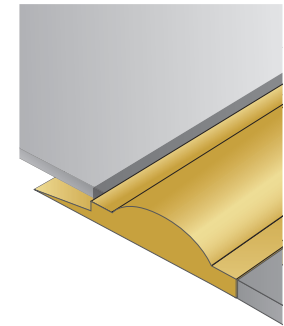

Shower threshold profile

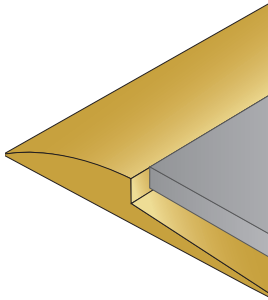

Ramp edges

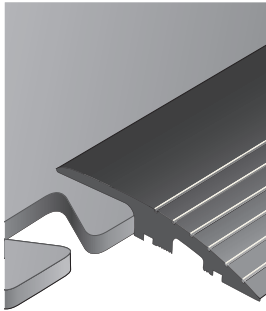

Aluminium profiles

2 Ramp edges

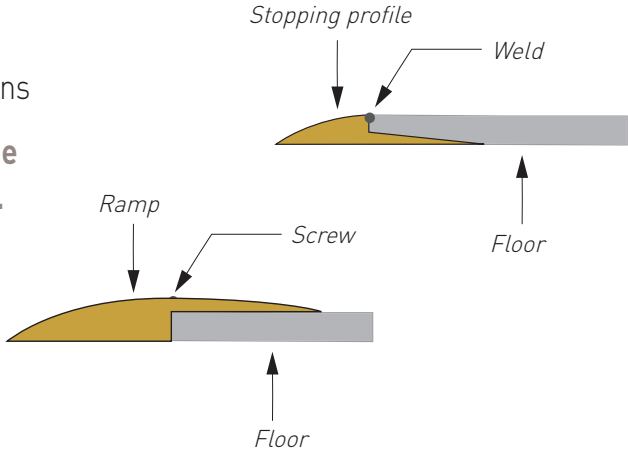

The vinyl floor/bare spot connections

Protect the edging and prevent the floor covering from delaminating.

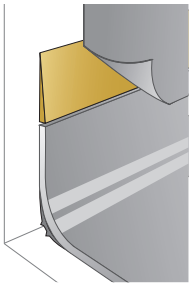
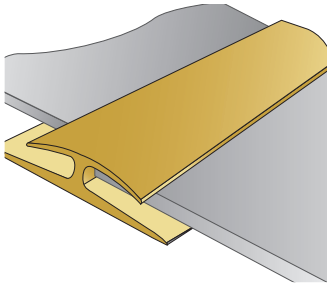

FINISHES

PVC CONNECTING PROFILES

	Floor to wall profile	Floor to floor connecting profiles
Description	 <p>0490</p> <p>DIMINISHING PROFILE</p> <ul style="list-style-type: none"> ▶ Coving/wall covering connection ▶ Used in laboratories, hospital shower systems, commercial kitchens 	 <p>0495</p> <p>P1224</p> <ul style="list-style-type: none"> ▶ These products allow the link between two floor coverings to be made
Colors	 6512	 6512 4203
Benefits	<ul style="list-style-type: none"> ▶ Makes it easier to link the floor covering and wall. ▶ Hygienic. Avoids bacteria accumulation ▶ Prevents the floor covering from tearing, improves durability and ensures watertightness. 	<ul style="list-style-type: none"> ▶ Junction between two floors ranging up to 4 mm thick ▶ Floor covering coverage system
Tips	<ul style="list-style-type: none"> ● <i>Bonding with acrylic adhesive</i> 	<ul style="list-style-type: none"> ● <i>Polychloroprene double bonding</i>

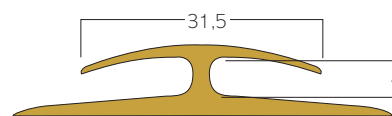
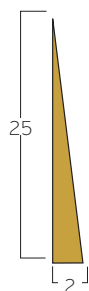

PVC CONNECTING PROFILES

Floor to floor connecting profiles

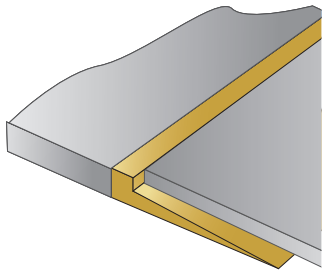

P1509

- ▶ These products allow the link between two-floor coverings to be made

0496



- ▶ Junction between two floors of 2.2 mm and 5 mm
- ▶ Floor covering can be welded to profile to create a watertight seal
- ▶ **Can also be used as a finishing profile**

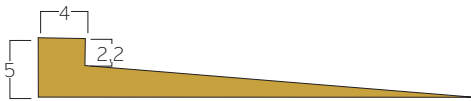

- Polychloroprene double bonding

Shower threshold profile

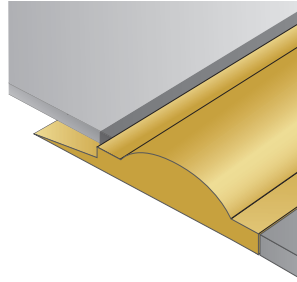

SHOWER THRESHOLD

- ▶ Makes the junction between a floor covering and a shower covering

0469

EXCLUSIVE TO GERFLOR



- ▶ **Allows welding of 2 mm or 3.5 mm floor covering** thanks to the **tab** system
- ▶ **Weld** system with the covering which ensures perfect **watertightness**

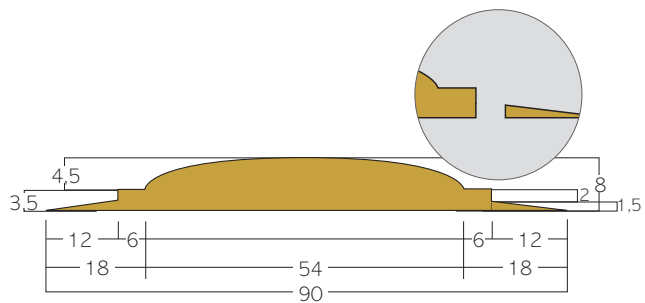

- The tab can be cut to suite a thicker floor
- Polychloroprene double bonding
- Application of sealant around the door jamb (PU or MS polymer sealant)

Colours and images are not contractual.

FINISHES

RAMP EDGES

Ramp edges

Description

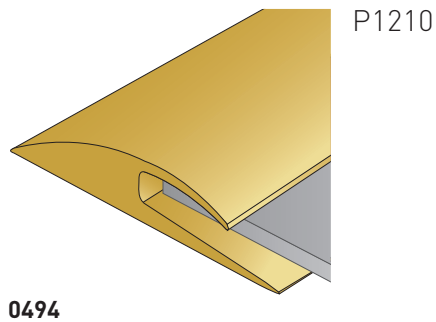

▶ Connect other surfaces and vinyl floors

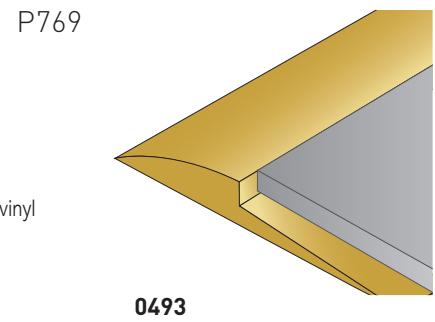

Colors

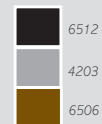

Benefits

- ▶ Floor covering coverage system
- ▶ Suitable up to 3.5 mm floors

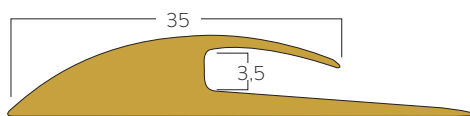

- ▶ Floor covering **welding** system
- ▶ Suitable for 2 mm floors
- ▶ Ensures watertight seal
- ▶ Can also be used as a capping strip

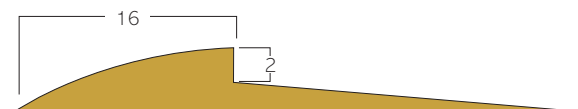

Tips

- Double bonding

RAMP EDGES

Aluminium profiles GTI, Creation and Attraction®

New

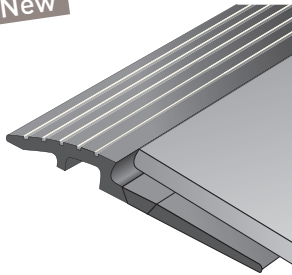

CREATION

0560

GTI / ATTRACTION®

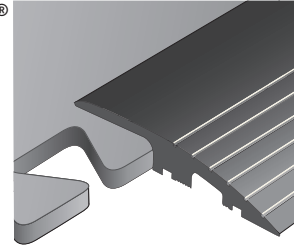

H202 - H205

► Access ramps resistant to high traffic and humidity



Products suitable for floor coverings of:

- 2,5 mm (**Creation**)
- 5 mm (**Attraction®** and **TX Multi-Use 5.0**)
- 6 mm (**GTI/GTI MAX** and **TX Multi-Use 6.2**)

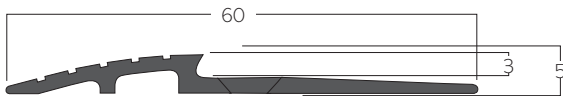

Creation 0560

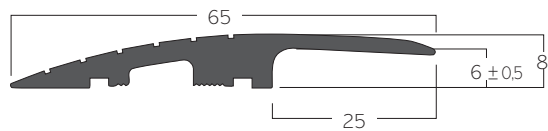

GTI H202

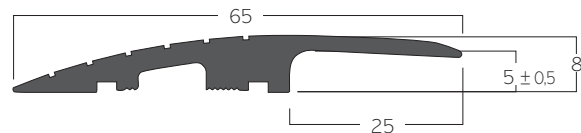

Attraction® H205

- *Screwing of the floor covering to the floor with flat cross head countersunk stainless steel screws (not included)*

Colours and images are not contractual.

WELDING SOLUTIONS

Two types of welding solutions exist:

1 Hot weld

- ▶ This is used for all types of PVC floors, for coving sport floors
- ▶ Ensures a complete watertight seal

Gerflor has a large range of Rod available

The welding rod is placed in the chamfer between two floor coverings. When heated, it melts and fills the entire space to ensure complete watertight seal.

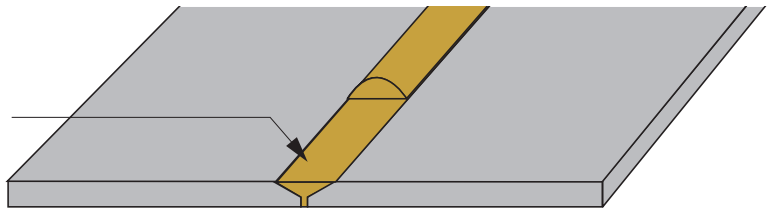

2 Cold weld

- ▶ Quick to implement
- ▶ Application on all types of PVCs except homogeneous ones
- ▶ Does not require specific equipment
- ▶ No watertightness

Gerflor offers SG916, a solution for cold treatment of joints:

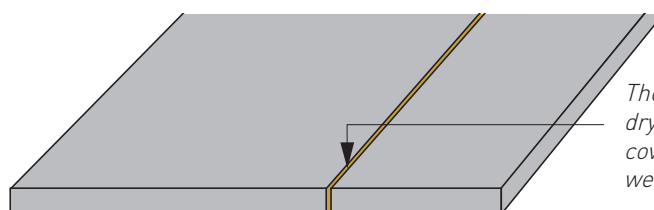

The product is inserted by dry joint between the floor coverings to ensure the weld (SG 916)

WELDS

Hot weld

Cold weld

Description



WELD RODS

- Ø 4 mm
- Ø 4,1 mm
- Ø 5 mm
- Ø 6 mm



SG 916

- In kit - code 0548
- In tube - code 0518

Benefits

- ▶ **CR40** : Floor/floor weld - *Code 0585*
- ▶ **CR41** : Shower wall weld - *Code H231*
- ▶ **CR50** : Welding of sport floors - *Code H209*

Specific weld rods

- ▶ **CR50** : Weld, Tarasafe Plus, floor repairs on special order - *Code H009*
- ▶ **CA72** : Triangular rod for commercial kitchen floor to base welding - *Code H007*
- ▶ **CR60** : Welding of sport floors, repair on special order - *Code H011*
- ▶ **BBR40** : 100% Bio-based plasticizer rod for Mipolam Symbioz

Please contact us for further information on weld rods

- ▶ Cold treatment of joints for sheet floor coverings, **except homogeneous ones**
- ▶ **Colourless** solution used irrespective of the material colour
- ▶ **Excellent finishing quality**: prevents all visible joint line traces joint

Tips

- For a better weld the correct grooving should be performed.
- Use an adapted nozzle (*Ultra Speed Nozzle*).

- Wait at least four hours before using the rooms
- Observe all the usual precautions: contains a flammable solvent.

Colours and images are not contractual.

OUR SPORT FINISHES

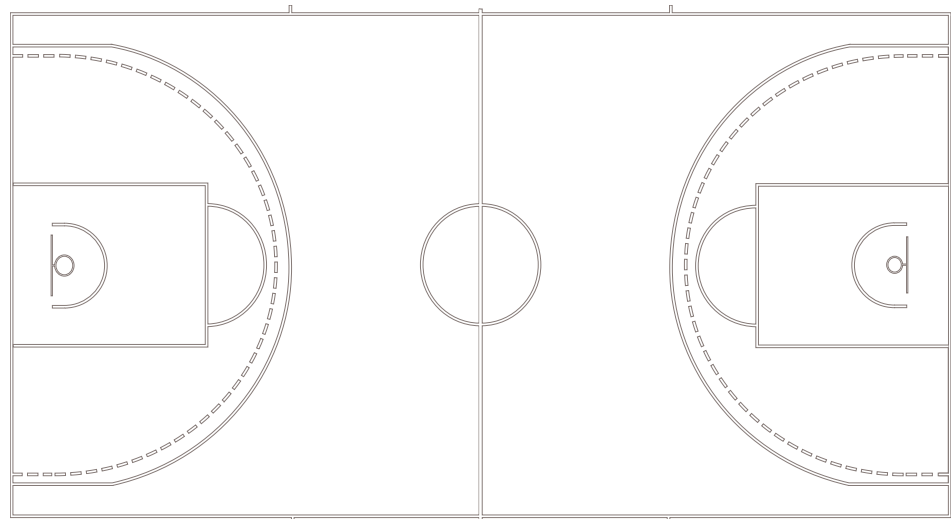

We provide finishing solutions suitable for sports floor coverings such as permanent or temporary line marking solutions.

Line marking of sports floors _____ P 236

- Permanent marking: Paints P 238
- Temporary marking: Game line marking P 239



LINE MARKING OF SPORTS

Gerflor provides a full range of products for marking temporary and permanent game lines.



Each colour is adapted to a specific line depending on the sport in question

1 Permanent marking

Permanent marking withstands cleaning and friction from shoes

- ▶ Kits specific to each sport
- ▶ TLD (Très Longue Durée – Very Long Term) paint (retail)

These colours are the official line colours however customised colours can be provided upon request

FLOORS

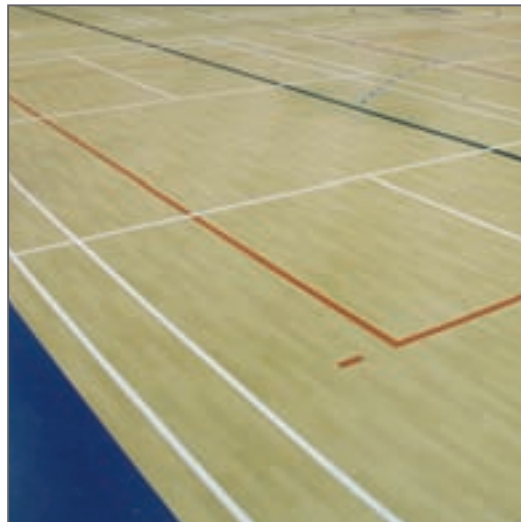

2 Temporary marking

Temporary marking enables quick implementation and removal

- ▶ **Coloured adhesive tape**

SPORTS FINISHES

MARKING

Permanent marking

Description



TLD + PAINT KIT

1 kit for one line



RETAIL TLD + PAINT

H030

TLD (Très Longue Durée – Long long Term) Paint was specifically developed to resist the stresses from sports being played on gymnasium floors.

These kits include:

- ▶ Paint in the same colour as official lines
- ▶ Hardener
- ▶ Protective adhesive
- ▶ Flat paint brush

Order an equivalent quantity (in units) of hardener

Colors



H031 - Basket Ball

H032 - HandBall

H033 - Volley Ball



H034 - Tennis

H035 - Badminton

085c 1001 - TLD+ paint hardener

H160 - Tennis primer 3kg can

087L 0081 - Protective adhesive



0001

0002

0004



0007

0006

Please contact us for customised paint and kits.

Benefits

- ▶ After mixing the paint and hardener, wait 20 minutes before application.
- ▶ Minimum drying time: 48 hours

Installation:

- ▶ Polyurethane based paint.
- ▶ Humidity sensitive components: do not apply on wet surfaces.

SPECIFIC CASE OF TARAFLEX® TENNIS: because of its shape and embossing depth, a Tennis Primer needs to be applied to smooth out and prevent paint from running under adhesive strips outlining the lines. Primer must be applied at least 2 hours before applying Taraflex Sport TLD+

Tips

MARKING

Temporary marking



COLOURED ADHESIVE STRIPS

Coloured adhesive strips are ideal for temporary installations

Adhesive strips 3M 471

- H197 0005
- H373 0201
- H197 0006
- H197 0004 - H207 0003 - H211 0009 - H266 0001
- H197 0002
- H266 0001 Bandes tennis Stamark

NUMBER OF ADHESIVE STRIPS FOR 1 LINE	
Tennis	2 rolls of Stamark tennis strips
Handball	10 yellow 3M adhesive strips
Volleyball	4 white 3M adhesive strips
Futsal	10 white 3M adhesive strips
Basketball	9 red 3M adhesive strips

White is recommended in a single set

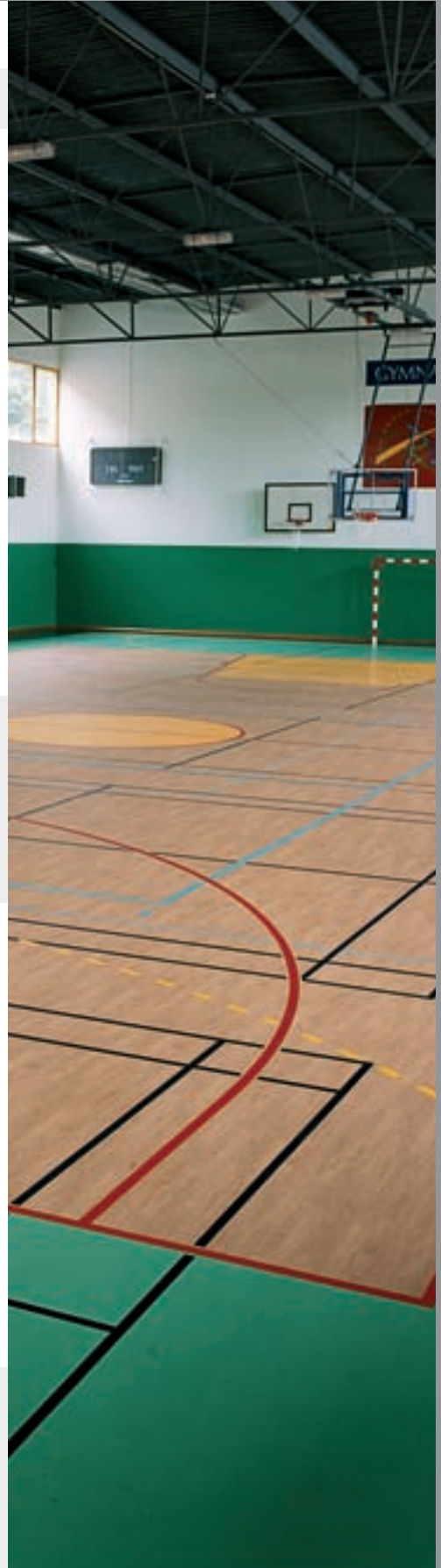

TECHNICAL



Gerflor offers a full range of technical solutions such as the shower system, copper strips, adhesives or tools in order to provide all the technical requirements on site.

SHOWER SOLUTIONS



Perfect CR 41 wall weld



Cove former for internal wall angles CA 12

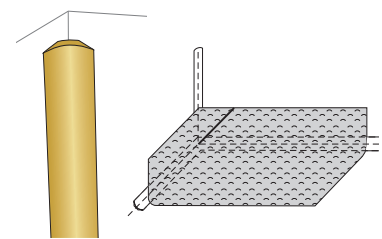

Diminishing profile

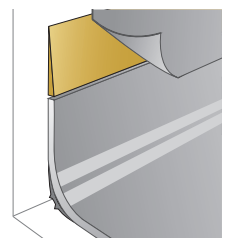

Cove former

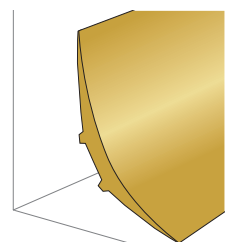

Shower threshold

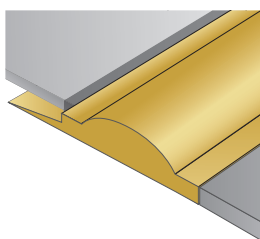

Tarafoam: acoustic insulation sub-layer



Drains



SHOWER SYSTEM

A complete floor and wall solution with a choice of two floor coverings, one wall covering and seven accessories.

- **Safety**
Grained floor covering with slip resistance
- **Watertight system**
floor/wall junction
- **System which guarantees hygiene**
- **Combination of colours**
11 wall references and 15 floor references
- **Access for all**

SHOWER SYSTEM

Drains / Gullies

Description



SITAR
DRAIN

H112

Drains are made from white injected PVC.
They enable:

- ▶ Drainage of water
- ▶ Compatibility with the Shower System
- ▶ Complete watertightness by PVC/PVC bonding
- ▶ Fire rating NF-M1

SITAR V
DRAIN



H113

Colors



001



001

Benefits

- ▶ An **adjustable ring** depending on the screeds
- ▶ Height adjustment
- ▶ **2 outlets (horizontal and vertical)** allow for flexibility on site
- ▶ 50 mm trap seal

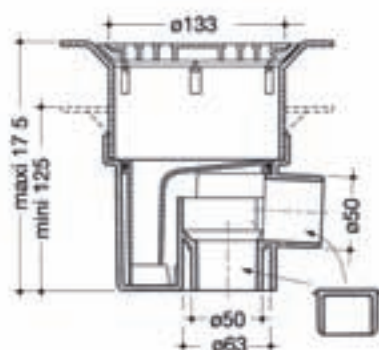

- ▶ **Integral drain with vertical drainage**
- ▶ 50 mm trap seal

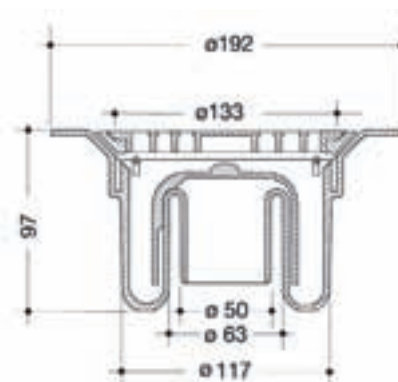

Tips

- The floor covering is filled into the gully to a watertight seal

Colours and images are not contractual.

SHOWER SYSTEM

Cove former for internal angles

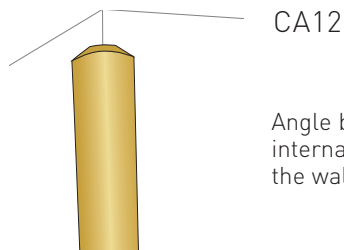

CA12

Angle bead to be placed in the internal angles before installing the wall covering

H204

Tarafoam



COMFORT VERSION OF THE SHOWER SYSTEM

To be used only with Brasilia SD.

997C 6792

0719

- ▶ Eliminates potential puncture damage to internal corners.
- ▶ **Size:** 12 mm

- ▶ Provides acoustic insulation for the shower system (15dB) and comfort under foot.
- ▶ To be used only with Brasilia SD.
- ▶ Thickness: 2 mm.

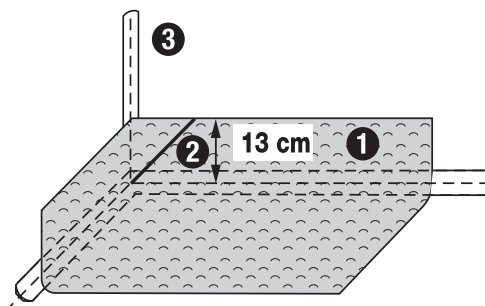

- 1 Cove the floor up to a height of 130 mm.
- 2 Cut the floor covering at 45° and weld the CR 40 rod.
- 3 Wall angle: double bonding of the CA 12 to the entire height.





The CR41 welding bead is specially adapted for shower system wall welds. Use the ultra fast nozzle*

- Levels out around the edge of the room
- Acrylic bonding
- Edge to edge installation

TECHNICAL SOLUTIONS

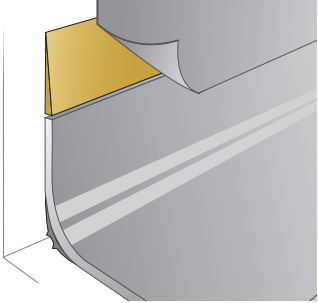
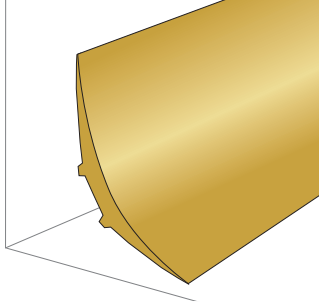
SHOWER SYSTEM

	PVC wall covering/coving junction	Cove former
Description	 <p>DIMINISHING PROFILE</p> <p>Coving / vinyl wall covering junction</p> <p>0490</p>	 <p>PVC COVE FORMER</p> <p>0478</p>
Colors	 6512	 6512
Benefits	<ul style="list-style-type: none"> ▶ Adjust thickness between the floor and wall covering ▶ Makes it easier to weld ▶ Prevents floor covering from tearing, improves its durability ▶ Ensures watertightness 	<ul style="list-style-type: none"> ▶ Enables coving and allows watertightness ▶ Its rounded shape makes it easier to clean the floor/wall junction ▶ Offers a better look ▶ Limits the risk of piercing the floor covering ▶ Prevents accumulation of bacteria
Tips	<ul style="list-style-type: none"> ● Bond with acrylic adhesive 	<ul style="list-style-type: none"> ● Only a single 45° angle is cut ● Double bonding (polychloroprene type) ● Use a miter shear * for a perfect cut

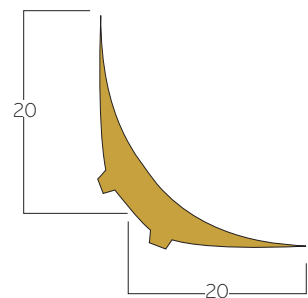
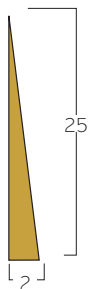

SHOWER SYSTEM

PVC shower threshold profile

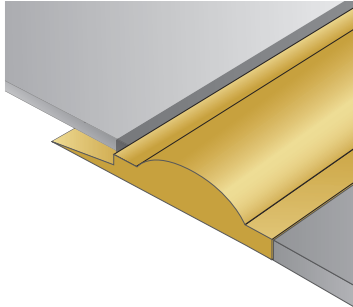

PVC SHOWER THRESHOLD PROFILE

Makes the connection between a floor covering and a shower flooring

0469

EXCLUSIVE TO GERFLOR



- ▶ Enables 2 mm or 3.5 mm floor covering to be welded thanks to the removable tab system
- ▶ Can be welded to the floor covering to ensure a watertight seal

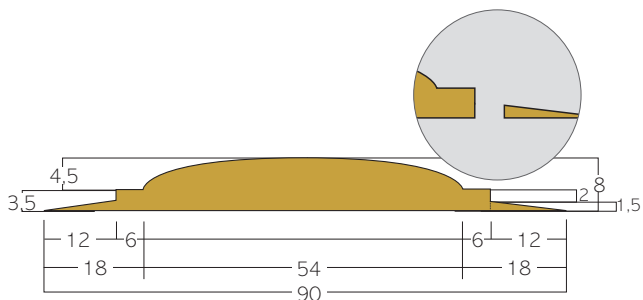

- Removable tab if the floor covering is thicker
- Double bonding (polychloroprene)
- Application of sealant around door jambs

Colours and images are not contractual.



SPECIFIC

Gerflor provides a set of products providing solutions to specific insulation, maintenance of floors and electrical conductivity of



Isolating membranes



ESD copper strip

PRODUCTS

problems such as accessibility,
our floors.

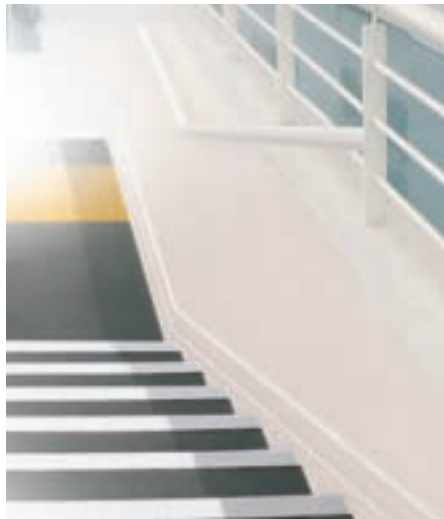

Accessibility



Gerflor Corner System



Maintenance

TECHNICAL SOLUTIONS

ISOLATING MEMBRANES

Isolsport

Description

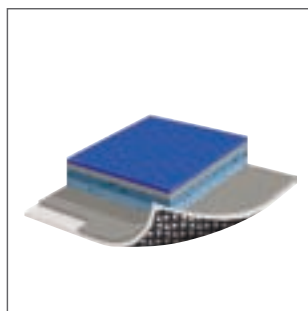

VINYL ISOLATING MEMBRANE

Specially designed for sports

For installation on concrete subfloors

0829 0002

Benefits

- ▶ Vinyl isolating membrane, double side on non woven glass fibre with backing design made up of 3-branch star foam pads.
- ▶ Its design enables loose laying on sensitive subfloors (risks of humidity, coated, etc.) when it is associated with a Taraflex sporting floor. The raised effect allows humidity to circulate.
- ▶ Thickness : 1,7mm

Tips

- *Bond well at doors with PU adhesive to prevent delamination.*
- *Keep the raised surface, floor side, on the periphery*
- *Edge to edge installation*
- *Bond vinyl floors with Gertec adhesive*



ISOLATING MEMBRANES

Bateco



H375 6801

PROTECTIVE
SURFACE

**Specially designed
for sports**

Suitable for
gymnasium /
reception hall
versatility

- ▶ **Protective surface** made from black calendared and grained plasticised vinyl.
- ▶ Taraflex Bateco is especially designed to protect sport floors in the event of non-sportive use of the room. It prevents marking by chairs, tables, heels on the sport floor.
- ▶ Thickness: 1,5mm

- *Edge to edge installation*
- *Strips can be secured with single-sided adhesive tape*

Tarafoam



997C 6792

COMFORT VERSION
OF THE SHOWER
SYSTEM

**To be used only with
Brazilia SD.**

- ▶ Provides **acoustic insulation for the shower system** (15 dB) and comfort under foot
- ▶ To be used only with Brasilia SD
- ▶ Thickness: 2 mm

- *Levels out around the edge of the room*
- *Acrylic bonding*
- *Edge to edge installation*

Colours and images are not contractual.

TECHNICAL SOLUTIONS

SPECIFIC ACCESSORIES

Description

Copper strip



ESD COPPER STRIP

Copper strip enabling earthing

0586 0001

Benefits

- ▶ For electro-conductive floor coverings such as Elegance EL5, Technic EL5, Accord EL7
- ▶ Width 10 mm, thickness 0.08 mm.

Tips

- Prevent discontinuity between the angles by folding it back onto itself

Sport floor maintenance



TRACIFLEX

085B 0011

- ▶ Multipurpose detergent for cleaning the vinyl sport floors (shoe marks and contact marks)
- ▶ Also suitable for floors which are difficult to clean

- ▶ Removes resin from Handball courts
- ▶ Recommended in sport room



- Traciflex may be sprayed on stubborn stains

SPECIFIC ACCESSORIES

Sport floor maintenance

New



DYNATECH TROPHY

085E 0001

- ▶ Multipurpose detergent for cleaning the vinyl sport floors (shoe marks and contact marks)
- ▶ Also suitable for floors which are difficult hard to clean

- ▶ For all sport floors



Protcsol® Floor Maintenance



SPRAY
TARACLEAN

085A 0010

- ▶ Spray cleaner to remove occasional and tough stains

- ▶ Suited to all types of floors treated with Protcsol®
- ▶ Easy and quick to use

Colours and images are not contractual.

TECHNICAL SOLUTIONS

ACCESSIBILITY

Tactile Strip



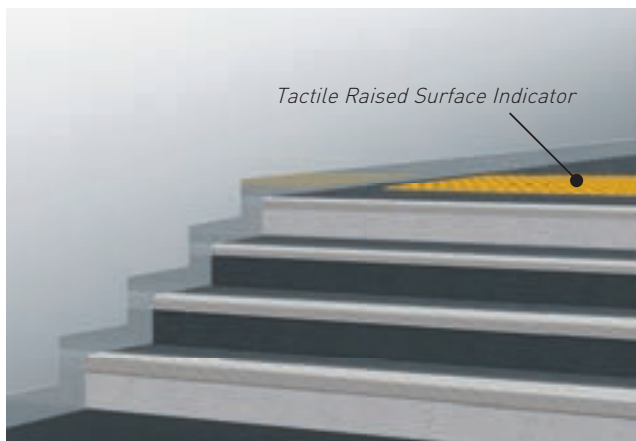

TACTILE STRIP

Tactile strips with pads to create visual and tactile contrast with the floor

**Tactile Strip, 2 formats: L008 2000 x 400 mm
L009 1350 x 400 mm**



0005 Yellow



0007 light Grey



0009 Dark Grey

- ▶ For blind or visually impaired people
 - ▶ Wear and fire resistant
 - ▶ Surface treatment: ProtecSol®
 - ▶ Fungistatic and bacteriostatic: Sanosol®
-
- ▶ Total thickness: 3.50 mm
 - ▶ Wear layer thickness: 1.20 mm
 - ▶ Dimensions: 400 x 1350 mm / 400 x 2000 mm

Colours and images are not contractual.

GERFLOR CORNER SYSTEM

Corner system

A unique system which makes cleaning in the corners more efficient and hygienic. The Gerflor Corner System is a technical installation for internal and external angles which uses a specially cut piece of flooring to eliminate the need for corner welding.

A patented system

The Gerflor Corner System is unique in the world and is patented for use with Gerflor Homogeneous floor coverings.

Designed to meet the exacting requirements of end user clients

The Gerflor Corner System has been tested and recommended by some of the largest pharmaceutical laboratories. It is designed to fully meet hygiene and microbial decontaminations specified in GMP (Good Manufacturing Practice) practical guides.

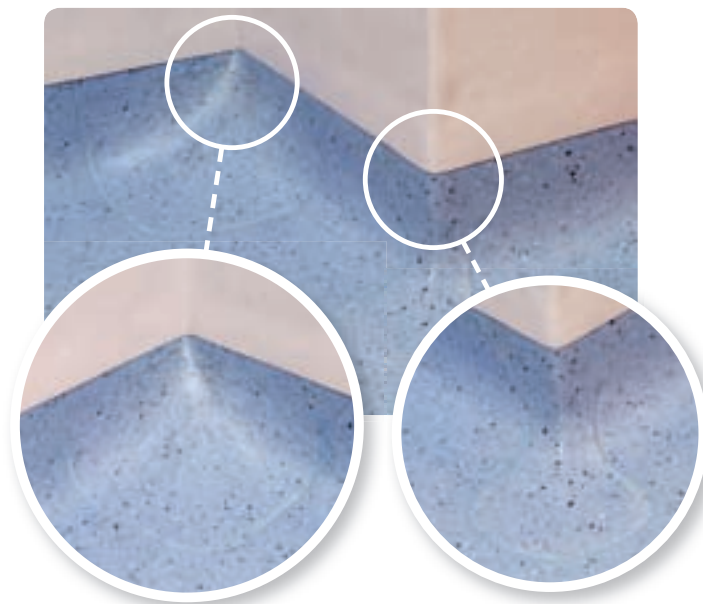

- ▶ **Easy to clean and decontaminate**
Tight, inaccessible corners do no longer exist
- ▶ **Smooth and durable**
No more vulnerable corner welds
- ▶ **Attractive and uniform finish**
Quality results
- ▶ **Consistency**
All corners are handled in the same way

GERFLOR CORNER SYSTEM

Training

The Gerflor Corner System is accessible to floor laying companies who have been trained by the Gerflor technical department or any other training organisation authorised by Gerflor.

Available technical tools

Gerflor Corner System video upon request

Detailed Gerflor Corner System installation process plan available at the end of the training workshop.

Internal corners

Shells 2R

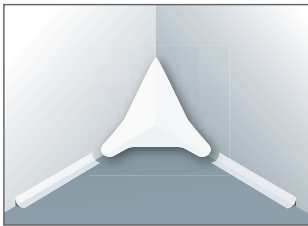

H223

Shells 3R

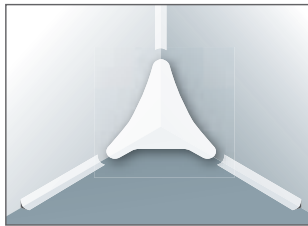

H235

Template in



H221

Material needed:

- Neopren adhesive
- 38 mm cove formers

External angles

Gerflor Corner System tool



H222

Template out

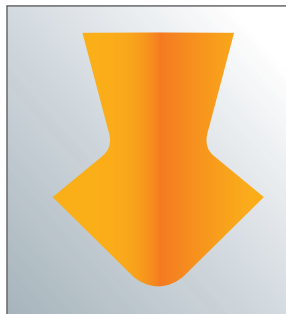

H220

Material needed:

- Pressure adhesive
- Neopren adhesive
- Cold spray
- 38 mm cove formers

ADHESIVES AND TAPES

Gerflor has developed specific bonding solutions to make it easier to install its products.



Adhesives



Tapes



ADHESIVES

Adhesives

Description



GERPUR M

Specially designed for sports

Only for Dry Tex™ System
(bonding of Taraflex sport floors with non-woven backing)

086C 0083



GERTEC

Application on floors with old vinyl floor covering for renovation or on Isolsport

0991 0991

Benefits

- ▶ Bonding on new and old humid concrete subfloor
- ▶ Mono component PU adhesive, reactive to humidity which enables the DTX material to be fully bonded in humid environment (no restriction of humidity levels with the exception of surface water)
- ▶ Consumption: 400 to 450g/m²

- ▶ Acrylic adhesive
- ▶ Adapted to Isolsport and other sport floors
- ▶ Consumption: 150 to 200 g/m²

Tips

- To be applied with ergonomic trowel for rigid adhesive and B1 blade

- To be applied with a stiff aluminium trowel and blade A4 Standard TKB

ADHESIVES

Adhesives



0973 0973

GERFIX SUPER
E 120

Apply on a hydraulic
base or resurfacing





- ▶ Acrylic adhesive
- ▶ Consumption: 300 to 350g/m²

- To be applied with a stiff aluminium trowel and blade A2 Standard TKB

Colours and images are not contractual.

TECHNICAL SOLUTIONS

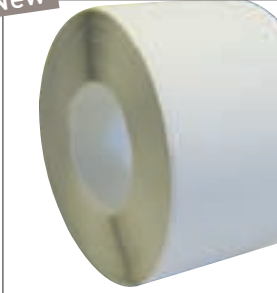
HOOK AND LOOP TAPE / DOUBLE SIDE TAPES

	Hook and loop tape for textile backing	Double sided tapes for textile backing
Description	<p>New</p>  <p>V107</p> <p>Hook and loop tape</p> <p>0556 0001</p> <p>Width: 107 mm</p>	<p>New</p>  <p>D75</p> <p>Double sided tape</p> <p>0534 0001</p> <p>Width: 75 mm</p>
Benefits	<ul style="list-style-type: none">▶ V107 and D75 enable installation of Transit Tex and vinyl floor coverings with textile backing on the perimeter and under joints▶ Time saving and cleanliness by comparison with a bonded system.▶ No gumming time and no smell	
Tips		

HOOK AND LOOP TAPE / DOUBLE SIDE TAPES

Double sided tapes for sport floors

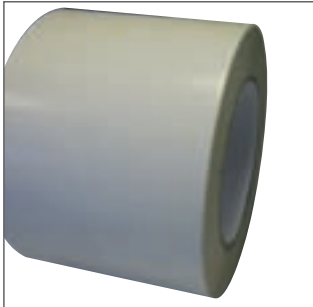

D 200
D 300

D 200: Special double sided tape for wood floors

D 300: Special double sided tape for concrete

H208 0007 / H210 0008

Width: 100 mm

- ▶ Adapted to temporary installation on wood floors or concrete
- ▶ Requires a test on site for validation

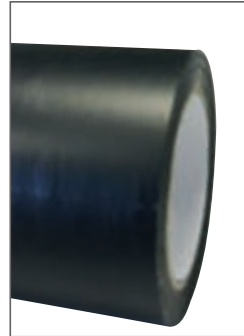

AT7

Single-side tape

H206 0001

Width: 100 mm

- ▶ Black
- ▶ Bonds without leaving marks, non migrating

Holds strips:

1. During non sportive events
2. Enables the material to be secured on the tube at the time of winding
3. Holds strips during the storage time

Required material

- AT7 tape reel
- Double side tape reel

Refer to the product glossary for information on colours and packaging

TOOLS

Gerflor provides tools to facilitate installation and treatment of floor covering.

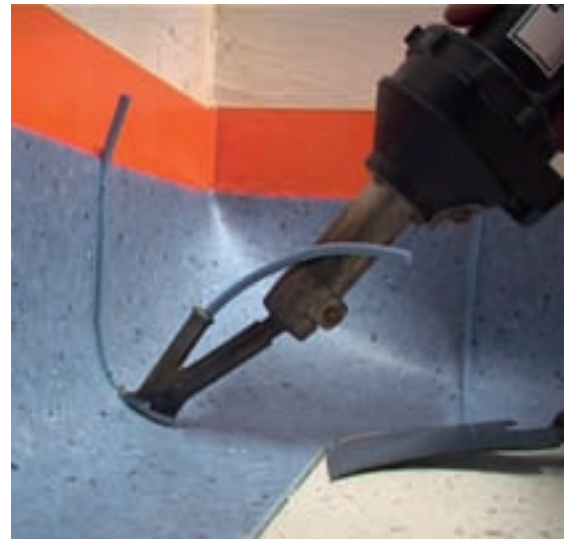



Welding – Chamfering



0565 0001

MANUAL BEVELLING MACHINE

Manual beveling machine, easy to transport. Does not require electricity, quick to use. The depth of the chamfer can be adjusted. Do not use for floor coverings from the Tarasafe range.

0541 0001

BLADE

10 blades



0569 0001

MANUEL GROOVING TOOL

Chamfer for Tarasafe, specifically designed for Tarasafe floor coverings and commercial kitchens.



0543 0001

TRIANGULAR BEVEL TOOL

Specially suited for wall covering and Shower Mural grooving.

Welded - Welding



0563 0001

ULTRA SPEED NOZZLE

For perfect CR 40, CR50, CR41 welds (without damaging the surface treatment).



0564 0001

SPEED WELD ROLLER NOZZLE FOR BEAD CA72

For angle weld with CA72 in industrial kitchens.

Welding - Shaving



0561 0001

TRIMMING KNIFE (MOZART)
(sold with 2 trimming guides 0.5 and 0.7)

Knife which only trims the width of the weld rod. One or two runs are needed. 2 tools in 1 = trimming guide and trimming knife.

0542 0001

BLADE FOR MOZART TRIMMING KNIFE

5 blades



0562 0001

EDGE TRIMMER

Trimming knife which allows the weld rod to be trimmed in the coves.

Cutting



0531 0001

SEAM CUTTER

For precise cutting of dry joint (SG916) or slightly open strips.

0567 0001

BLADE FOR SEAM CUTTER

10 blades



0566 0001

MITER SHEAR

Enables precise cutting of all finishes.



0532 0000

CUR RESISTANT GLOVES

Knitted mesh gloves. Extremely lightweight and ventilated.

Sizes : 8 (ref. code 0008), 9 (ref. code 0009), 10 (ref. code 0010), 11 (ref. code 0011)

Bonding

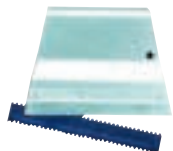

0545 0001

ALUMINIUM TROWEL

Width 18 cm
Aluminium adhesive trowel with interchangeable blade type A2 / A4 (delivered without comb).
To be used with Gerfix Super EI20 adhesive.



0547 0001

SPARE BLADE A2, TKB STANDARD

Width 18 cm, Consumption = 300-350 g/m² 10 blades.
To be used with the Gerfix Super E120 adhesive.



0536 0001

SPARE BLADE A4, TKB STANDARD

Width 18 cm, Consumption = 150-170 g/m² 10 blades.
To be used with the Gerfec adhesive



0535 0001

ERGONOMIC TROWEL FOR RIGID ADHESIVE

Width 21 cm
Ergonomic trowel with type B1 interchangeable blade (delivered without comb).
To be used with the Gerpur M adhesive.



0533 0001

SPARE BLADE B1

Width 21 cm, Consumption = 400-450g/m² 10 blades.

Specific Products

Shower wall or Mural Ultra installation



0529 0001

INTERNAL ANGLE PRESSURE ROLLER

Smooths the material in angles (prevents delamination of the material). Product adapted for smoothing internal angles.

Specific Products



0544 0001

EXTERNAL ANGLE PRESSURE ROLLER

Smooths the material in angles (prevents delamination of the material). Product adapted for smoothing external angles.



0528 0001

SKIRTING RULER

For easy installation of coves in shower systems and industrial kitchens. It allows the height of the cove to be cut (13 cm for the ground, 10 cm for the wall).

Skirting installation



0540 0001

SKIRTING CORNER CUTTER

To cut the angles of the Vynaflex Skirting.

GTI, GTI MAX, Attraction®, Creation Clic System installation



0530 0001

PLANK & TILE MALLET

Used to install GTI, GTI MAX, Attraction® / Creation / Creation Clic System tiles.

Stair installation



0527 0001

MARCHIGRAPH

Used for Tarastep installation.

SPORT TOOLS



H372 0001

DOUBLE SIDE TAPE REEL

Accessories used for unwinding double-side tapes D200, D300.



H367 0003

SINGLE SIDE TAPE REEL

Accessories used for unwinding single-side. Tape AT7 and holding BATECO strips together.



H295 0001

RESTRAINING STRAP VELCRO STRIPS

L=2.10m for 60 cm dia. rolls approximately.

Storers



WALL ATTACHED FLOOR COVERING STORAGE

Gerflor also offers:
Wall attached floor covering storage for 4, 6 or 8 rolls
Width: 1,5 meter*



SERVING TROLLEY - STORERS

A serving trolley; floor covering storer on wheels for 6 or 8 rolls.
Motorised. Unwinds, winds up, raises and stores the floor covering rolls. Adapted to Bateco and sports floors.
Width: 1,5 meter*

**2 meters available on special request*



A RANGE OF ADDITIONAL
ACCESSORIES FOR ASSISTING
INSTALLATIONS (pressure rollers, strap
hoists,...)

*Item codes: refer to glossary.
For more information, please contact the Gerflor
sales department.*